

Please read and save these instructions. Read carefully before attempting to assemble, install, operate or maintain the product described. Protect yourself and others by observing all safety information. Failure to comply with instructions could result in personal injury, death and/or property damage! Retain instructions for future reference.



Finishing Nailer

Description

This nailer is designed for trimwork, interior molding, baseboards, paneling and cabinet assembly and installation. Features include: convenient side loading magazine which holds up to 100 nails, no-mar tip, adjustable exhaust, single cycle trigger and quick clear nose.

General Safety Information

This manual contains safety, operational and maintenance information.

Read this manual and understand all safety warnings and instructions before operating the nailer. Contact your Campbell Hausfeld representative if you have any questions.

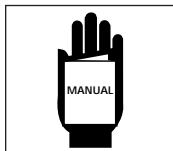

The operator of this nailer must take the necessary precautions to prevent unsafe conditions outlined in this manual from occurring. The operator is also required to read and understand this instruction manual and all safety warnings, labels, etc.

Any employer allowing the use of this nailer in their field of work must distribute this instruction manual to all users. The employer must also ensure all users read, understand and follow the instructions as described in the manual, safety warnings, labels, etc.

⚠ DANGER Danger indicates an imminently hazardous situation which, if not avoided, WILL result in death or serious injury.

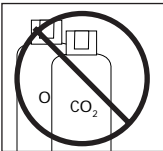
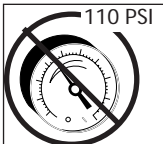
- Do not use any type of flammable gases or oxygen as a power source for the nailer. Use filtered, lubricated, regulated compressed air only. Use of a compressed gas instead of compressed air may cause the nailer to explode and cause death or serious personal injury. 
- Do not exceed maximum operating pressure of the nailer (110 PSI). The nailer will not function 

properly. Do not use a compressed air source capable of more than 200 PSI. The nailer could explode and cause death or serious personal injury.

- Never use gasoline or other flammable liquids to clean the nailer. Never use the nailer in the presence of flammable liquids or gases. Vapors could ignite by a spark and cause an explosion which will result in death or serious personal injury. 

- Always place yourself in a firmly balanced position when using or handling the nailer. 
- Do not modify or disable the Work Contact Element (WCE) in a depressed position or tape or modify the trigger in a pulled position. Death or serious personal injury will occur. 

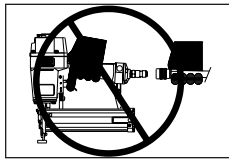
- Never keep the trigger pulled when carrying or holding the nailer. Make sure not to pull the trigger or depress the work contact element (WCE) trip mechanism when connecting the nailer to an air compressor. Death or serious puncture wounds will occur if the work contact element (WCE) bumps something. 

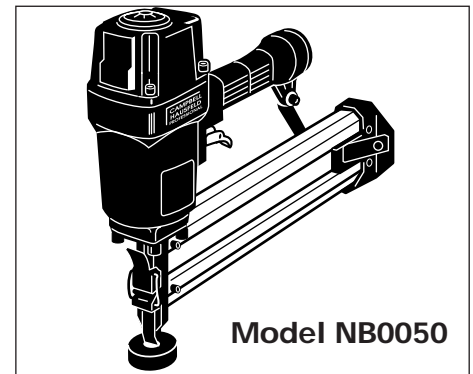

Model NB0050

⚠ WARNING Warning indicates a potentially hazardous situation which, if not avoided, COULD result in death or serious injury.

- Disconnect the nailer from air supply before adjusting, clearing jams, servicing, relocating and during non-operation. Remember it is possible for the nailer to eject a fastener after servicing the tool. ALWAYS reconnect the air lines before loading any fasteners. Death or serious personal injury could result. 
- Protect your eyes and ears. Wear Z87 safety glasses, with side shields. Wear hearing protection. Employers and users are responsible for ensuring the user or anyone near the nailer wears this safety protection. Serious eye injury or permanent hearing loss could result. 

- Do not use a check valve or any other fitting which allows air to remain in the nailer. Serious personal injury could occur. 

Warning Continued

- Never place your hand or any part of your body in the nail discharge area of the nailer. It is possible for the nailer to eject a fastener and could result in death or serious personal injury.



- Never carry the nailer by the air hose or pull the hose to move the nailer or a compressor. Keep hoses away from heat, oil and sharp edges. Replace any hose that is damaged, weak or worn. Personal injury or tool damage could occur.

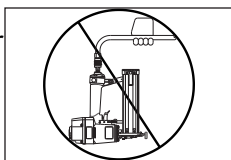

- Always assume the nailer contains nails. Never use the nailer as a toy. Do not engage in horseplay. Always keep others at a safe distance from the work area in case of accidental discharge of nails. Never point the nailer at anyone. Accidental triggering of the nailer could result in death or serious personal injury.

- Do not drive a nail on top of other nails. The nail could glance and cause death or a serious puncture wound.

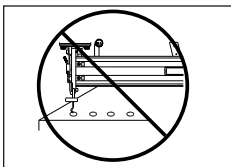

- Do not operate or allow anyone else to operate the nailer if any warnings or warning labels are not legible. Warnings or warning labels are located on the nailer magazine and body.

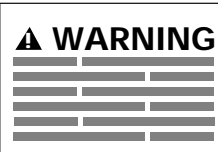

- Never leave the nailer unattended or connected to an air compressor when not in use. Serious personal injury can occur if someone picks up and uses the nailer without knowing the correct way to operate the nailer.

- Do not drop or throw the tool. Dropping or throwing the tool can result in damage that will make the tool unusable or unsafe. If the tool has been dropped or thrown, examine the tool closely for bent, cracked or broken parts and air leaks. STOP and repair before using or serious injury could occur.

CAUTION Caution indicates a potentially hazardous situation which, if not avoided, MAY result in minor or moderate injury.

- Do not modify or alter the nailer or any nailer parts. Do not use the nailer if any shields or guards are removed or altered. Do not use the nailer as a hammer. Serious personal injury may occur.

- Avoid long extended periods of work with the nailer. The nailer can harm the user's hands or arm. Stop using the nailer if pain occurs.

- Always check the work contact element (WCE) trip mechanism of the nailer. A nail could accidentally be driven if the triggering mechanism is not working properly. Serious personal injury may occur.

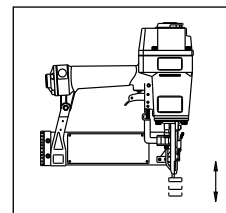

- Disconnect air supply and release tension from the pusher before attempting to clear jams because fasteners can be ejected from the front of the nailer. Personal injury may occur.

NOTICE Notice indicates important information, that if not followed, may cause damage to equipment.

- Avoid using the nailer when there are no nails in the magazine. Accelerated wear on the nailer may occur.

- Clean and check all air supply hoses and fittings before connecting the nailer to compressor. Replace any damaged or worn hoses or fittings. Tool performance or durability may be reduced.

- Air compressors providing air to the nailer should follow the requirements established by the American National Standards Institute Standard B19.3-1991; Safety Standard for Compressors for Process Industries. Contact your air compressor manufacturer for information.

Nailer Components And Specifications

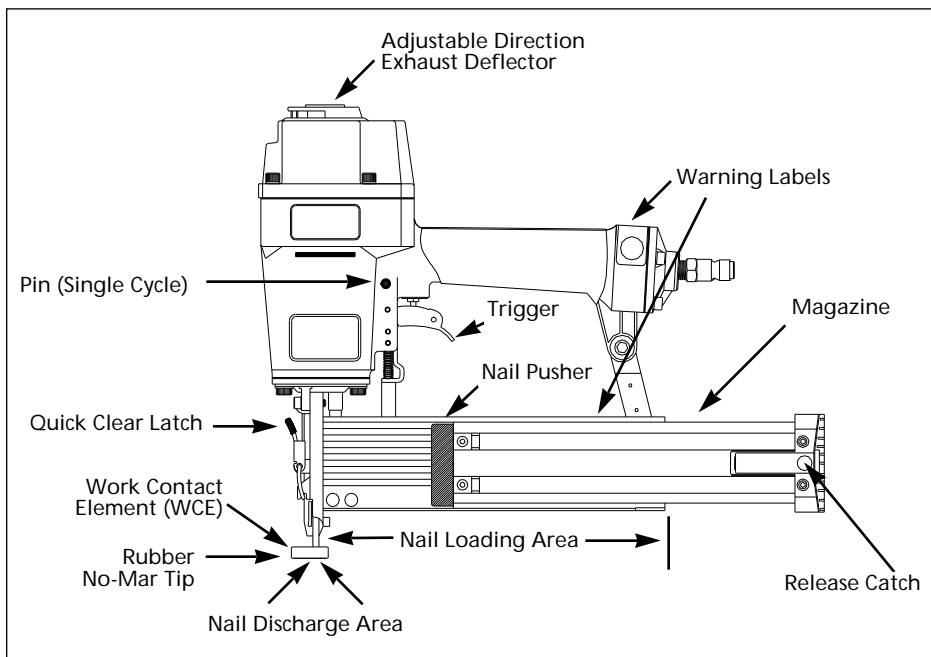

- **REQUIRES:** 1.5 SCFM with 10 nails per minute @ 90 PSI
- **AIR INLET:** 1/4" NPT
- **NAIL SIZE RANGE:** 3/4" to 2"
- **MAGAZINE CAPACITY:** 100 Nails per load, 16 gauge
- **WEIGHT:** 4 lbs., 13 oz.
- **LENGTH:** 11-1/2"
- **HEIGHT:** 11-1/2"
- **MAXIMUM PRESSURE:** 110 PSI
- **PRESSURE RANGE:** 70 - 110 PSI

Table Of Contents

- General Safety1
- Specifications2
- Using The Nailer3
- Operational Modes3
- Operating The Nailer4
- Troubleshooting6
- Warranty7

Using The Nailer

Read this manual and understand all safety warnings and instructions before operating the nailer.

LUBRICATION

This nailer requires lubrication before using the nailer for the first time and before each use. If an inline oiler is used, manual lubrication through the air inlet is **not** required on a daily basis.

▲ NOTICE *The work surface can become damaged by excessive lubrication. Proper lubrication is the owner's responsibility. Failure to lubricate the nailer properly will dramatically shorten the life of the nailer and void your warranty.*

1. Disconnect the air supply from the nailer to add lubricant.

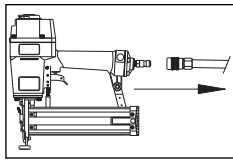

2. Turn the nailer so the air inlet is facing up and put 4-to-5 drops of 30 W non-detergent oil into air inlet. Do not use detergent oil or oil additives. Run the nailer briefly after adding oil and wipe off excessive oil at the exhaust.

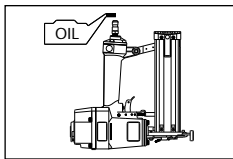

RECOMMENDED HOOKUP

The illustration below shows the recommended hookup for the nailer.

1. The air compressor must be able to maintain a minimum of 70 PSI when the nailer is being used. An inadequate air supply can cause a loss of power and inconsistent driving.



2. An oiler can be used to provide oil circulation through the nailer. A filter can be used to remove liquid and solid impurities which can rust or "gum up" internal parts of the nailer.

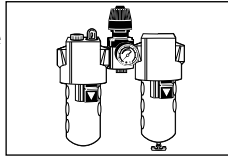

3. Use 3/8" air hoses with a minimum working pressure of 150 PSI. Use 1/2" air hoses for 50' run or longer. For better performance, install a 3/8" quick plug with (1/4" NPT threads) with an inside diameter of .315 (8mm) on the nailer and a 3/8" quick coupler on the air hose.
4. Use a pressure regulator on the compressor, with an operating pressure of 0 - 125 PSI. A pressure regulator is required to control the operating pressure of the nailer.

Operational Modes

The NB0050 finish nailer may be operated in the "Single Cycle" or the "Bottom Trip" mode. The nailer comes delivered in the single cycle mode. A pin when in place in the nailer allows you to operate in the single cycle mode. When the pin is removed, the nailer will operate in the bottom trip mode.

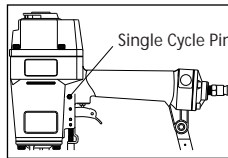

▲ WARNING *Always know the operational mode of the nailer before using. Failure to know the operational mode could result in death or serious personal injury.*

SINGLE CYCLE MODE

This method is recommended when precise nail placement is required. The single cycle pin must be installed in the nailer. This mode requires the trigger to be pulled each time a nail is driven. The nailer can be actuated by depressing the WCE against the work surface followed by pulling the trigger. Or the nailer can be actuated by pulling the trigger and then depressing the WCE against the work surface.

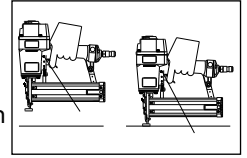

The trigger must be released to reset the tool before another nail can be driven.

If the tool is in bottom trip mode because the single cycle pin has previously been removed, reinstall the single cycle pin to convert the tool back to single cycle mode.

BOTTOM TRIP MODE

This method is recommended when less precise nail placement is required. The single cycle pin must be removed from the nailer. Remove the pin by removing the o-ring on one end and pushing the pin out. Replace the o-rings on the pin after removing the pin from the nailer and keep the pin assembly for later use.

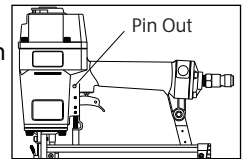

Bottom trip operation requires the trigger to be pulled with the nailer off the work surface. Then, the nose of the nailer is tapped against the work surface causing a nail to be driven.

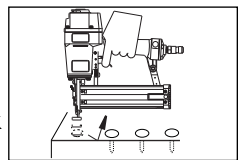

Recommended Hookup

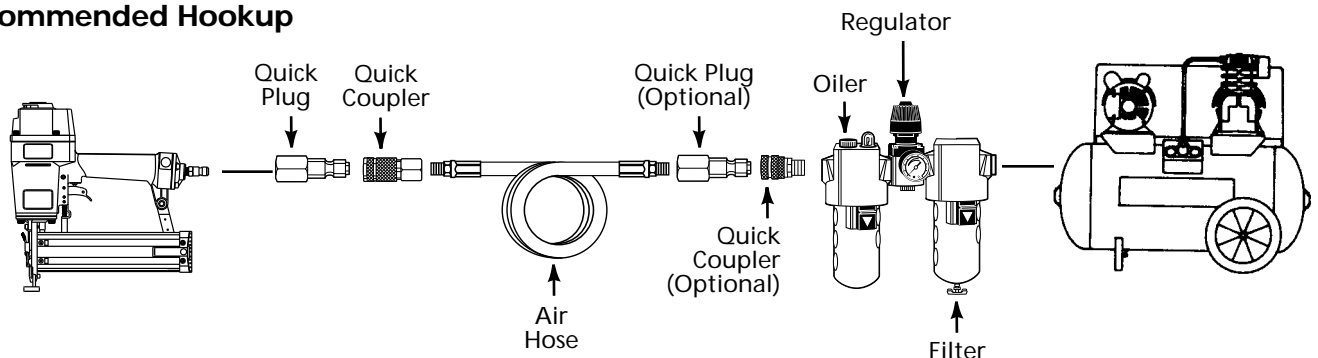

Each time the Work Contact Element (WCE) is depressed, a nail is driven into the work surface. Care should be taken when using this method because a nail will be driven when the WCE is depressed by any surface.

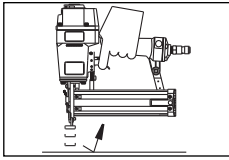

To convert the tool back to single cycle operation, reinstall the single cycle pin and attach an o-ring to each end.

Operating The Nailer

▲WARNING *Disconnect the nailer from the air compressor before adjusting, clearing jams, servicing, relocating, and during non-operation.*

WORK CONTACT ELEMENT (WCE)

▲CAUTION *Check the operation of the Work Contact Element (WCE) trip mechanism before each use. The WCE must move freely without binding through its entire travel distance. The WCE spring must return the WCE to its fully extended position after being depressed. Do not operate the nailer if the WCE trip mechanism is not operating properly. Personal injury may occur.*

1. Disconnect the air supply from the nailer.

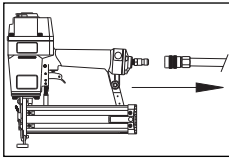

2. Remove all nails from the magazine (See Loading-Unloading)

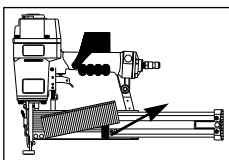

3. Make sure the trigger and work contact element (WCE) move freely up and down without sticking or binding.

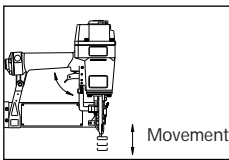

4. Reconnect air supply to the nailer.

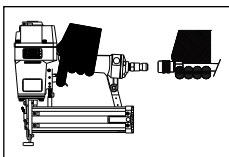

5. Depress the work contact element (WCE) against the work surface without pulling the trigger. The nailer **MUST NOT** cycle. Do not use the nailer if it cycles. Personal injury could result.

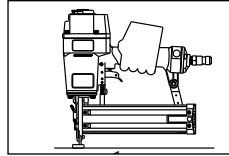

6. Hold the nailer clear of the work surface. The work contact element (WCE) should return to its original down position. Pull the trigger. The nailer **MUST NOT** cycle. Do not use the nailer if a cycle occurs. Personal injury could result.

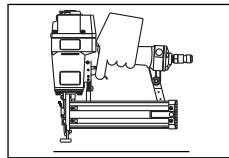

7. Pull the trigger and depress the work contact element (WCE) against the work surface. The nailer **MUST** cycle.

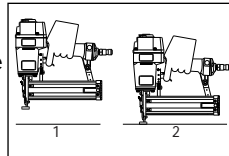

8. Depress the work contact element (WCE) against the work surface. Pull the trigger. The nailer **MUST** cycle.

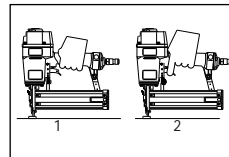

LOADING/UNLOADING THE NAILER

1. Always **connect** the tool to the air supply before **loading** fasteners.
2. Press down on the latch. Pull back on the magazine cover.
3. Insert a stick of Campbell Hausfeld nails or equivalent (See Fastener Section) into the magazine. Make sure the pointed ends of the nails are resting on the bottom ledge of the magazine when loading. Make sure the nails are not dirty or damaged.
4. Push the magazine cover forward until the latch catches.

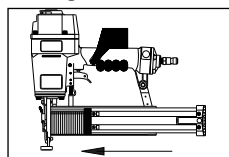
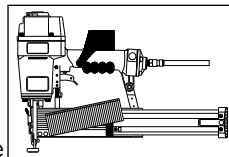
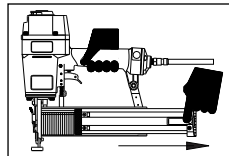

5. **Unloading** is the reverse of loading, except **always disconnect** the air hose before proceeding.

ADJUSTING THE NAIL PENETRATION

1. Regulate the air pressure to 70 PSI at the nailer.
2. Connect the air hoses and test for penetration by driving nails into a sample piece of wood. If the nails do not achieve the desired penetration, adjust the air pressure to a higher setting until the desired penetration is achieved. Do not exceed 110 PSI at the nailer or durability of the nailer will be reduced.

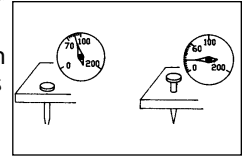

ADJUSTING THE DIRECTION OF THE EXHAUST

The NB0050 is equipped with an adjustable direction exhaust deflector. This is intended to allow the user to change the direction of the exhaust. Simply twist the deflector to any direction desired.

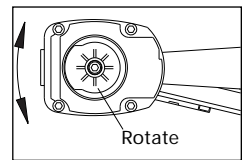

CLEARING A JAM FROM THE NAILER

1. Disconnect the air supply from the nailer.
2. Remove all nails from the magazine. Failure to do so will cause the nails to eject from the front when the quick clear mechanism is opened and the jam is removed.
3. Undo latch by pulling out and down. The wire latch will disengage from the hooks on the nose casting.

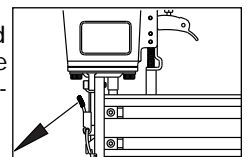
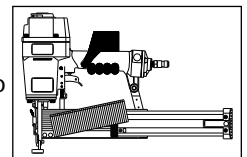
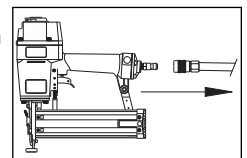

4. The driver cover plate can now be rotated, exposing the jammed fastener.

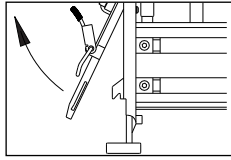

5. Remove the jammed fastener, using pliers or a screwdriver if required.

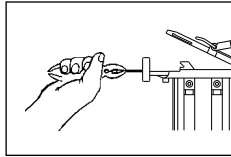

6. Rotate driver cover back into the closed position.

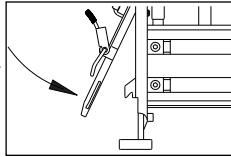

7. Extend the wire latch and place over the hooks on the nose casting.

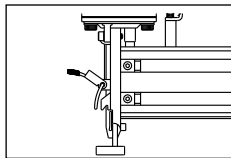

8. Close the over center latch by pushing the latch in until the latch snaps into place.

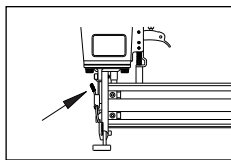

Technical Support

Should you have any questions regarding the operation or repair of this nailer, please call our Nailer Hotline at 1-800-543-6400 for assistance. If you are calling from Ohio or outside of the continental United States, please call collect, 1-513-367-1182.

Record the model number and serial number below:

Model No _____

Serial Number _____

Retain these number for future reference.

Fastener And Replacement Parts

⚠ WARNING Use only genuine Campbell Hausfeld fasteners (or equivalent) and replacement parts. Do not use modified parts or parts which will not give equivalent performance to the original equipment. Tool performance, safety and durability could be reduced. When ordering replacement parts or fasteners, specify by part number.

COLORMATCH™ System

The Campbell Hausfeld Finishing Nailer has a unique COLORMATCH™ stripe. Look for the COLORMATCH™ stripe to choose the right Campbell Hausfeld fasteners for your NB0050 2" finish nailer.

Nailer Repair

Nailer repairs must be performed by qualified and experienced service people ONLY.

Assembly Procedure For Seals

When repairing a nailer, the internal parts must be cleaned and lubricated. Parker O-lube or equivalent must be used on all o-rings. Each o-ring must be coated with O-lube before assembling. A small amount of oil must be used on all moving surfaces and pivots. After reassembling, a few drops of 30W non-detergent oil or equivalent, must be added through the air line before testing.

Fasteners

The following Campbell Hausfeld finishing nails are available at local retail stores. If you need help locating any item, call customer service at 1-800-543-6400. Campbell Hausfeld nails meet or exceed Federal Specifications FF-N-105B.

Model #	Length	Shank Gauge	Finish	Head	Collation	Nails Per Stick	Nails Per Box
FB003060	1-1/4"	16 Gauge	Galvanized	Brad	Adhesive	50	2500
FB004060	1-1/2"	16 Gauge	Galvanized	Brad	Adhesive	50	2500
FB004560	1-3/4"	16 Gauge	Galvanized	Brad	Adhesive	50	2500
FB005060	2"	16 Gauge	Galvanized	Brad	Adhesive	50	2500

Interchange Information

Nails used in the Campbell Hausfeld NB0050 Finishing Nailer will also work in Hitachi NT65A, Paslode 3250-F16, IM250F, Duo Fast LFN-764, Sears 18314, Porter Cable FN200 and FN250.

Troubleshooting Guide

⚠ WARNING *Stop using nailer immediately if any of the following problems occur. Serious personal injury could result. Any repairs or replacements must be done by a Qualified Service Person or Authorized Service Center.*

Problem	Cause	Solution
Air leaking at trigger valve	O-Rings in trigger valve housing are damaged	O-Rings must be replaced & operation of work contact element must be checked
Air leaking between housing and nose	Loose screws in housing	Screws need to be tightened
	Damaged O-Rings	O-Rings must be replaced
	Damage to bumper	Bumper needs to be replaced
Air leaking between housing and cap	Loose screws	Screws need to be tightened
	Damaged gasket	Gasket needs to be replaced
Nailer skips driving nail	Worn bumper	Bumper needs to be replaced
	Dirt in nose piece	Drive channel needs to be cleaned
	Dirt or damage prevent nails or pusher from moving freely in magazine	Magazine needs to be cleaned
	Damaged pusher spring	Spring needs to be replaced
	Inadequate air flow to nailer	Fitting, hose or compressor needs to be checked
	Worn O-Ring on piston or lack of lubrication	O-Rings need to be replaced. Lubricate.
	Damaged O-Ring on trigger valve	O-Rings need to be replaced
	Air leaks	Screws and fittings need to be tightened
Nailer runs slow or has loss of power	Cap gasket leaking	Gasket needs to be replaced
	Nailer not lubricated sufficiently	Nailer needs to be lubricated
	Broken spring in cylinder cap	Spring needs to be replaced
Nails are jammed in nailer	Exhaust port in cap is blocked	Damaged internal parts need to be replaced
	Guide on driver is worn	Guide needs to be replaced
	Nails are not correct size	Nails recommended for nailer must be use
	Nails are bent	Replace with undamaged nails
	Magazine or nose screws are loose	Screws need to be tightened
Air leaking at trigger valve stem	Driver is damaged	Driver needs to be replaced
	O-Rings or seals are damaged	O-Rings or seals need to be replaced

Limited Warranty

1. **DURATION:** One year from the date of purchase by the original purchaser.
 2. **WHO GIVES THIS WARRANTY (WARRANTOR):**
 - The Campbell Group
 - A Scott Fetzer Company
 - 100 Production Drive
 - Harrison, Ohio, 45030
 - Telephone: 1-800-543-6400.
 3. **WHO RECEIVES THIS WARRANTY (PURCHASER):** The original purchaser (other than for purposes of resale) of the Campbell Hausfeld product.
 4. **WHAT PRODUCTS ARE COVERED BY THIS WARRANTY:** Any Campbell Hausfeld nailer.
 5. **WHAT IS COVERED UNDER THIS WARRANTY:** Defects on material and workmanship which occur within the duration of the warranty period.
 6. **WHAT IS NOT COVERED UNDER THIS WARRANTY:**
 - A. Implied warranties, including those of merchantability and FITNESS FOR A PARTICULAR PURPOSE ARE LIMITED TO ONE YEAR FROM THE DATE OF ORIGINAL PURCHASE. Some states do not allow limitations on how long an implied warranty lasts, so the above limitations may not apply to you.
 - B. ANY INCIDENTAL, INDIRECT, OR CONSEQUENTIAL LOSS, DAMAGE, OR EXPENSE THAT MAY RESULT FROM ANY DEFECT, FAILURE, OR MALFUNCTION OF THE CAMPBELL HAUSFELD PRODUCT. Some states do not allow the exclusion or limitation of incidental or consequential damages, so the above limitation or exclusion may not apply to you.
 - C. Any failure that results from an accident, purchaser's abuse, neglect or failure to operate products in accordance with instructions provided in the owner's manual(s) supplied with product. Accident, purchaser's abuse, neglect or failure to operate products in accordance with instructions shall also include the removal or alteration of any safety devices. If such safety devices are removed or altered, this warranty is void.
 - D. Normal adjustments which are explained in the owner's manual(s) provided with the product.
 - E. Items or service that are normally required to maintain the product, i.e. o-rings, springs, bumpers, debris shield, driver, etc. These said normal wear items will be covered only for ninety days from the date of original purchase.
 7. **RESPONSIBILITIES OF WARRANTOR UNDER THIS WARRANTY:** Repair or replace, at Warrantor's option, products or components which have failed within duration of the warranty period.
 8. **RESPONSIBILITIES OF PURCHASER UNDER THIS WARRANTY:**
 - A. Deliver or ship the Campbell Hausfeld product or component to the nearest Campbell Hausfeld Authorized Service Center. Freight costs, if any, must be borne by the purchaser.
 - B. Use reasonable care in the operation and maintenance of the products as described in the owner's manual(s).
 9. **WHEN WARRANTOR WILL PERFORM REPAIR OR REPLACEMENT UNDER THIS WARRANTY:**
 - A. Repair or replacement will be scheduled and serviced according to the normal work flow at the servicing location, and depending on the availability of replacement parts.
 - B. If the purchaser does not receive satisfactory results from the Authorized Service Center, the purchaser should contact the Campbell Hausfeld Product Service Department (see paragraph 2).
- This Limited Warranty gives you specific legal rights and you may also have other rights which vary from state to state.

Notes