



















# HL410197DB Compressor and Accessory Kit

## TOOL & ACCESSORY KIT INCLUDES

### Tools and Accessories Included

-  HDT202 Impact Wrench
-  HDT103 Air Chisel
-  (1) Flat Chisel Bit
-  (1) Spring Retainer
-  Brad Nailer/Stapler
-  1" Brad Nails – pack
-  1" Crown Staples – pack
-  General Purpose Spray Gun Kit
-  25' Recoil Hose
-  Tire Inflation Gun
-  Blow Gun
-  Rubber Blow Gun Tip
-  Inflation Accessories (includes adapter, safety nozzle, extension blow gun nozzle, inflation needle, tapered inflation nozzle)
-  (4) Male Plugs
-  (2) Female Plugs
-  Female Universal Coupler

### For Replacement Order

- HDT20200XX  
Includes manual
- HDT10300XX  
Includes manual, spring, bit
- MP287500AV
- SV868900AV
- HDN23200XX  
Includes manual, brad nails and staples
- FB180025AV
- FN180625AV
- XX420001AV  
Includes manual and accessories
- MP268100AV
- MP600100XX  
Includes 1 female plug
- HDA50500AV
- MP246800AV  
(Pack of 2)
- MP211700AV  
(Pack of 2)
- MP333500AV

## COMPRESSOR KIT INCLUDES

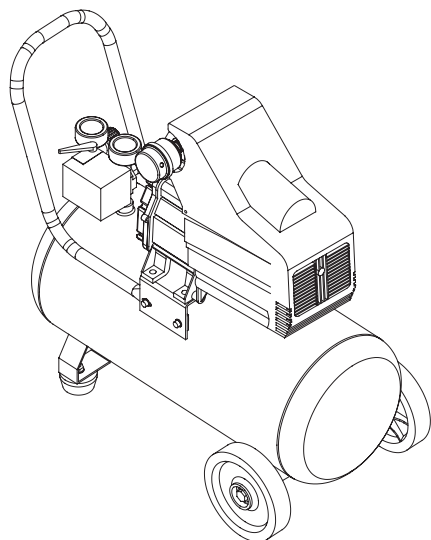

- 1.3 Running HP/8 Gallon Air Compressor HL410100AV
- Wheel Kit [Includes: (2) wheels, (2) Axle  
Bolts, (2) Hex Nuts, and (2) Lock Washers] HL021200AV
- Handle HL019700AV
- Handle Screw Kit [Includes: (4) Bolts, (4)  
Washers, and (4) Hex Nuts] HL021100AV
- Filter HL018200AV

# SET-UP INSTRUCTIONS



**APPLY THREAD TAPE TO  
= THREADED CONNECTIONS TO  
HELP ELIMINATE AIR LEAKS**



**OIL: FOR USE WITH CHISEL, IMPACT WRENCH AND NAILER/STAPLER. REFER TO OWNERS MANUAL FOR PROPER USE.**

