

Replacement Parts Manual

For Replacement Parts, Call 1-800-330-0712

Please provide following information:

- Model number
- Serial number (if any)
- Part description and number as shown in parts list





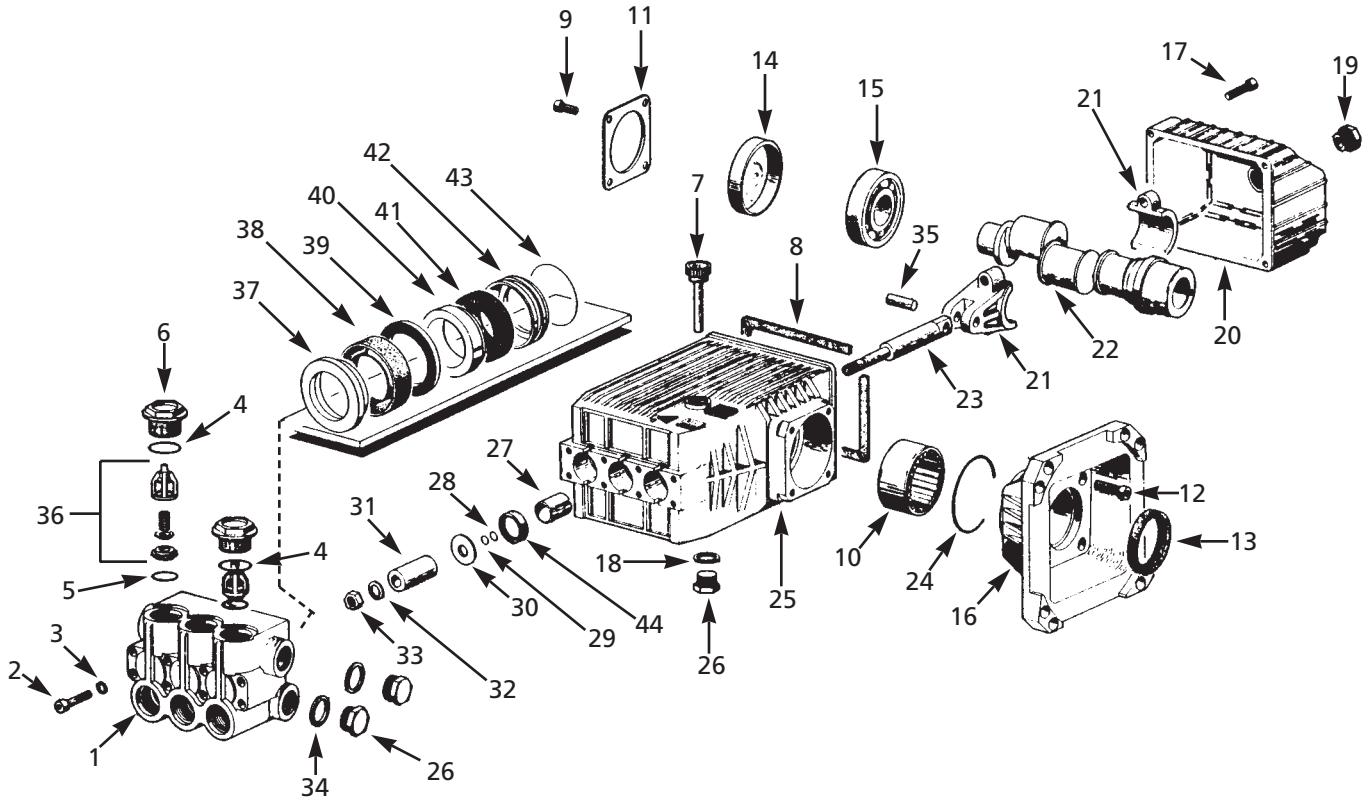

Address parts correspondence to:

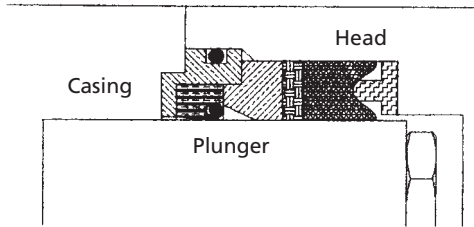
The Campbell Group
Attn: Parts Department
100 Production Drive
Harrison, OH 45030 U.S.A.



Seal Assembly



Item	Description	Kits
 37	XLG Package Adapter	† ★
 38	XLG Super U Pack	◆ †
 39	XLG Flat Check Ring	● †
 40	XLG Flat Front Brass	†
 41	Premium U Packing	◆
 42	Back Brass Gland	† ■
 43	Outside O-Ring	● ◆

TORQUE CHART

Item	Description	Tool	Part Number	Ft.-lbs.
2	Pump head bolt	5mm	PM048000SV	12
6	Brass valve cover	24mm	PM048400SV	88*
	Plated brass cover	24mm	PM048500SV	88*
9	Plunger rod nut	12mm	PM048800SV	12*

*With LocTite®

Ref. No.	Description	Part Number	Qty
1	Pump head (Forged Brass)	PM047800SV	1
2	Head bolt	PM048000SV	1
3	Ribbed locking washer	PM048100SV	1
4	▲ O-Ring	PM048300SV	1
5	△ O-Ring	PM048200SV	1
6	▲ Valve cover (Forged Brass)	PM048400SV	1
7	Vented dipstick	PM048600SV	1
8	Rear crankcase cover gasket	PM048700SV	1
9	Side cover bolt	PM048800SV	1
10	Needle bearing	PM048900SV	1
11	Side crankcase cover	PM049000SV	1
12	Gas flange bolt	PM049100SV	1
13	Oil seal crankshaft	PM049200SV	1
14	Rear bearing cap	PM049300SV	1
15	Bearing (SKF Straight Roller)	PM049500SV	1
16	Gas engine flange	PM049600SV	1
17	Rear crankcase cover bolt (Long)	PM049800SV	1
18	Copper gasket	PM049900SV	1
19	Oil sightglass with gasket	PM050000SV	1
20	Rear crankcase cover (Long)	PM050200SV	1
21	Connecting rod	PM050300SV	1
22	Crankshaft (All except PW3221 and PW3521)	PM050400SV	1
	Crankshaft (PW3221 and PW3521)	PM050500SV	1
23	Plunger rod (Tennifer Coated)	PM050900SV	1
24	O-Ring	PM051000SV	1
25	Pump crankcase	PM051100SV	1
26	Plug	PM051200SV	1
27	Self-lube, PTFE coated bushing	PM051300SV	1
28	Back-up ring	PM051400SV	1
29	O-Ring	PM051500SV	1
30	Splash ring	PM051600SV	1
31	18mm Solid ceramic plunger	PM051700SV	1
32	Copper washer	PM051800SV	1
33	Stainless nut	PM051900SV	1
34	Copper head plug gasket	PM052000SV	1
35	Connecting rod pin	PM052100SV	1
36	△◆ Check valve assembly	PM052200SV	1
37	†★ Oil seals	PM052300SV	1
38	† Water seals	PM052400SV	1
39	●† Flat check ring	PM052500SV	1
40	†■ Front flat brass gland	PM052600SV	1
41	◆ Pre-load U packing	PM052700SV	1
42	†■ Brass back gland	PM052600SV	1
43	●◆ O-Ring	PM052700SV	1
44	● Plunger oil seal	PM052600SV	1

***REPAIR KITS** (Refer to Seal Assembly on page 1)

△	Check valve assembly - For items 5 & 36 (Includes package of 6)	PM052200SV	1
●	Oil seals - For items 39, 43 & 44 (Includes package of 3)	PM052300SV	1
◆	Water seals - For items 38, 41 & 43 (Includes package of 3)	PM052400SV	1
†	Complete piston packing - For items 37, 38, 39, 40 & 42 (Includes package of 1)	PM052500SV	1
■	Two-piece gland - For items 40 & 42 (Includes package of 3)	PM052600SV	1
▲	Valve caps (Brass) - For items 4 & 6 (Includes package of 6)	PM052700SV	1
★	White Adaptor Rings - For item 37 (Includes package of 3)	PM052900SV	1